



Tischtennisplatte I-070

Art.-Nr.: 09.15.106.00



Balltrichter

Art.-Nr.: 09.40.220.02 verzinkt





Art.-Nr.: 09.40.220.04 V2A-Edelstahl





Tischtennisplatte I-070

Art.-Nr.: 09.15.106.00

Material:

- Platte und Unterbau aus Polymerbeton
- Plattenstärke aus 45 mm mit außen liegendem Kantenschutz aus Aluminium
- Feinschicht-Spielfläche ohne Poren und Unebenheiten
- Spielflächen Farbe grün, RAL 6005
- abgerundete Ecken
- Netz aus Aluminium Stärke 8 mm
- Gewicht 495 kg
- Bodenverankerung möglich
- geprüft nach DIN EN 15312

	ab 5 Jahre
	keiner
	ca. 2,74 x 1,52 m
	ca. 0,77 m
	keine

	ca. 1,52 x 1,40 x 0,20 m
	ca. 560 kg
	keine
	keine

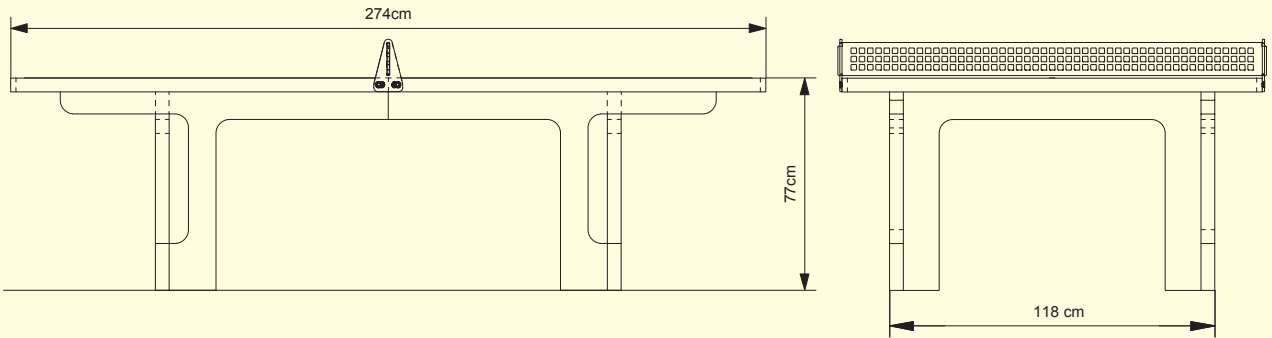





ohne Maßstab





Balltrichter

Art.-Nr.: 09.40.220.02/04

Material:

- Trichter in V2A-Edelstahl, glasperlgestrahlt, wahlweise verzinkt
- 3 Ausläufer
- Standpfosten aus Stahlrohr verzinkt, wahlweise pulverbeschichtet

	ab 6 Jahre
	keine
	ca. 1,25 x 1,25 m
	ca. 3,00 m
	keine

	ca. 1,20 x 1,25 x 3,80 m
	ca. 85 kg
	keine
	1 St. 0,80 x 0,80 x 0,80 m

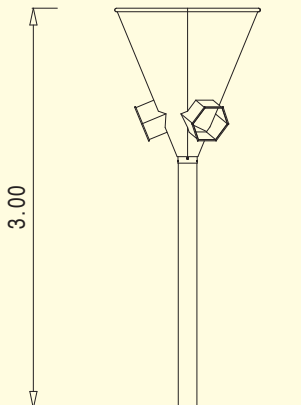

ohne Maßstab