











Wasserspielanlage Maxi H-280







Art.-Nr.: 08.45.001.33

Ausstattung:

- Automatikpumpe Jumbo aus V2A- Edelstahl, glasperlgestrahlt
- Pumpenpodest aus 15 mm HC Strukturplatte mit rutschhemmender Oberflächenprägung (R11), Standpfosten aus V2A- Edelstahl
- Wasserwaage aus V2A- Edelstahl
- V- Rinne aus HPL
- Rechteckige Wasserrinne aus HPL mit Verschlussstopfen
- runder Matschtisch aus HPL
- viereckiger Matschtisch aus HPL

	ab 3 Jahre
	ca. 7,64 x 5,77 m
	ca. 4,61 x 2,77 m
	ca. 1,25 m
	ca. 1,25 m

	-
	-
	-
	-

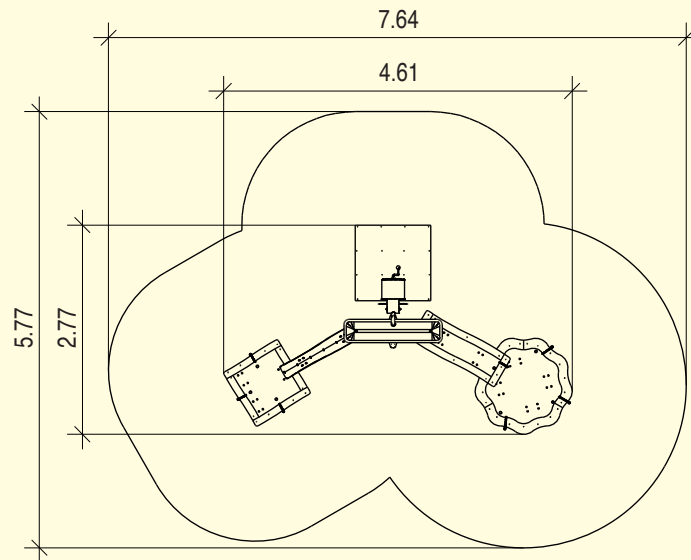
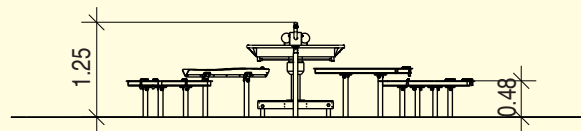

Maßstab 1:100