



Drehstange F-290

Art.-Nr.: 06.60.482.04



Stehkarussell F-290





Art.-Nr.: 06.60.460.04





Drehstange F-290

Art.-Nr.: 06.60.482.04

Material:

- Drehteller aus V2A-Edelstahl, \varnothing 56 cm
- Boden aus Fallschutzmaterial
- Haltestange aus V2A-Edelstahl
- doppelt gelagerte Drehwelle, Kugellager und Kunststoffgleitlager
- alle Edelstahlteile glasperlgestahlt

-  ab 3 Jahre
-  ca. \varnothing 4,50 m
-  ca. \varnothing 0,48 m
-  ca. 1,44 m
-  ca. 0,15 m

-  ca. \varnothing 2,45 x 0,56 m
-  ca. 40 kg
-  keine
-  1 St. 0,70 x 0,70 x 0,40 m

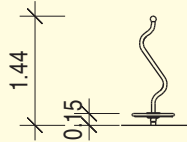
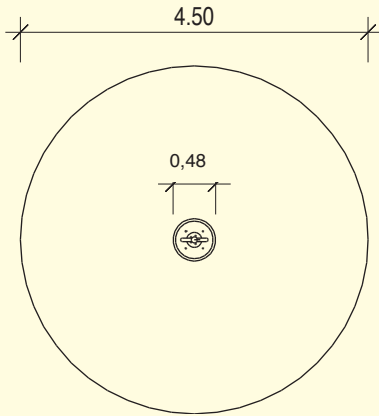
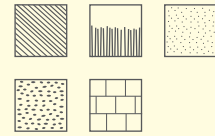





Maßstab 1:100





Stehkarussell F-290

Art.-Nr.: 06.60.460.04

Material:

- Rohrgeländer aus V2A-Edelstahl, \varnothing 3,4 cm
- Standfläche aus Fallschutzmaterial
- kugelgelagerte Drehplatte
- Tiefenverankerung aus verzinktem Stahl
- Bodenverankerung zum Einbetonieren

-  ab 3 Jahre
-  ca. \varnothing 4,57 m
-  ca. \varnothing 0,57 m
-  ca. 0,90 m
-  ca. 0,10 m

-  ca. \varnothing 0,57 x 1,70 m
-  ca. 55 kg
-  keine
-  1 St. 0,80 x 0,80 x 0,40 m

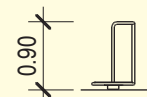
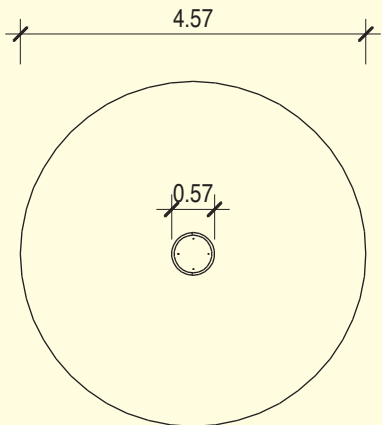
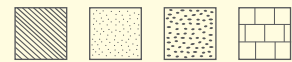

Maßstab 1:100