



## Startrampe für Seilbahn F-170

Art.-Nr.: 06.40.025.\*



## Doppel-Seilbahn F-160

Art.-Nr.: 06.45.020.\*

Art.-Nr.: 06.45.030.\*



Auch in Stahl  
erhältlich!











## Startrampe für Seilbahn F-170

Art.-Nr.: 06.40.025.\*

### Material:

- Unterzüge und Brüstungsriegel 9 x 7 cm
- Rampenbelag aus 15 mm HC Strukturplatte mit rutschhemmender Oberflächenprägung (R11) mit Tritthilfen
- formschlüssige Einfassungen der Standpfosten aus 15 mm HPL
- Standpfosten Ø 14 cm

-  ab 5 Jahre
-  ca. 5,45 x 4,14 m
-  ca. 2,46 x 1,14 m
-  ca. 1,95 m
-  ca. 0,97 m

-  ca. 2,45 x 0,80 x 0,15 m
-  ca. 250 kg
-  2 St. 11.00.010.62
-  2 St. 0,30 x 0,30 x 0,30 m  
2 St. 0,50 x 0,50 x 0,40 m

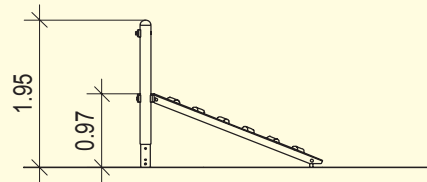
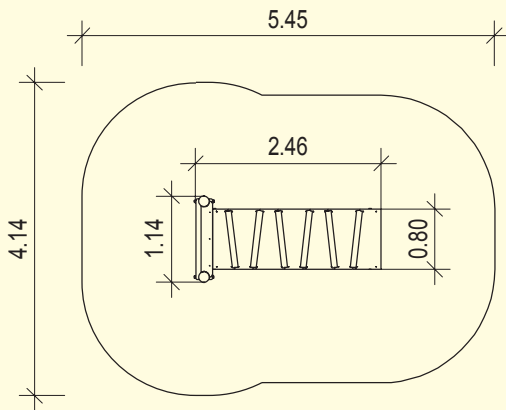
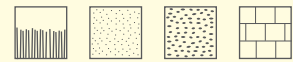

\*71 Douglasie  
\*72 Douglasie mit Metallpfosten





Maßstab 1:100





## Doppelseilbahn F-160

Art.-Nr.: 06.45.020.\*

### Material:

- Standpfosten aus Rundhölzern, Ø 14 cm
- Kopfbalken aus verzinktem Stahl
- Spezialdrahtseil, Ø 1,1 cm
- Seilspannvorrichtung mit Verriegelung
- Bremsfedern zum Abstoppen
- Seilbahnwagen mit Kunststoffrollen
- Pendelsitz aus Gummi mit schlauchüberzogener, verzinkter Kette (B6)

-  ab 5 Jahre
-  ca. 22,44 x 6,50 m
-  ca. 20,00 x 5,34 m
-  ca. 4,01 m
-  ca. 1,40 m

-  ca. 5,00 x Ø 0,18 m
-  ca. 50 kg
-  8 St. 11.00.005.62
-  8 St. 0,80 x 0,80 x 0,50 m

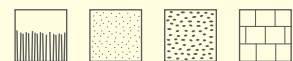

(D)

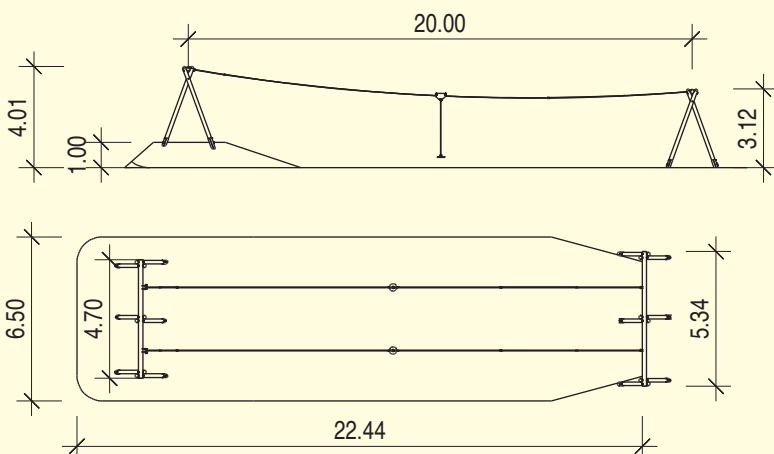

\*61 Douglasie  
\*02 Stahlpfosten verzinkt

ohne Maßstab