



## Kletternetzlaube E-050

Art.-Nr.: 05.00.035.02

Pulverbeschichtung  
optional  
erhältlich!



## Schiffsmast E-090

Art.-Nr.: 05.00.070.02





Ahoi! Die kleinen Piraten stechen wieder in See! Auf zu neuen Abenteuern! An der Strickleiter kann man mit Hilfe der schrägen Kletternetzwand den Mastkorb erklettern. Und husch, hinein in den Korb: Jetzt heißt es genau beobachten, ob sich jemand nähert.





## Kletternetzlaube E-050

Art.-Nr.: 05.00.035.02

### Material:

- Standpfosten und Kopfbalken aus verzinktem Rundrohr,  $\varnothing$  114 mm
- Kletternetz aus Polyamidstahltau, 4-farbig
- horizontales Netz aus Polyamidstahltau, 4-farbig
- Hangeseil aus Polyamidstahltau, 4-farbig
- Strickleiter aus Polyamidstahltau
- Sprossenwand aus V2A-Edelstahlrohr

-  ab 4 Jahre
-  ca. 6,53 x 7,87 m
-  ca. 2,36 x 3,61 m
-  ca. 2,25 m
-  ca. 2,25 m

-  -
-  -
-  keine
-  4 St. 0,70 x 0,70 x 0,40 m  
4 St. 0,40 x 0,40 x 0,40 m

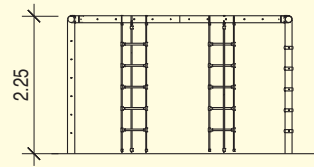
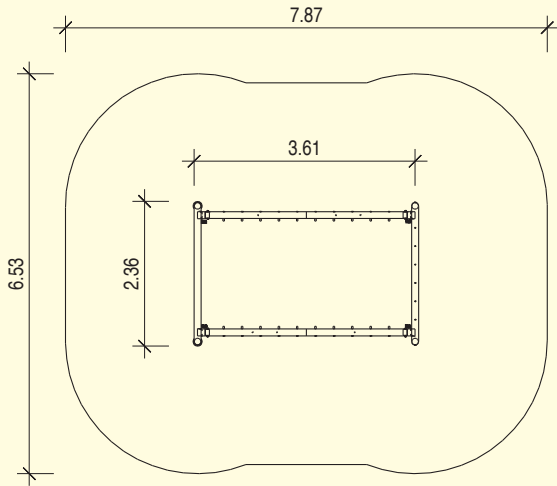
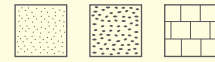





ohne Maßstab





## Schiffsmast E-090

Art.-Nr.: 05.00.070.02

### Material:

- Standpfosten aus verzinktem Rundrohr,  $\varnothing$  152 mm, wahlweise pulverbeschichtet
- Kletternetz aus Polyamidstahltau, 4-farbig
- Strickleiter aus Polyamidstahltau
- Maskorb verzinkt und pulverbeschichtet

-  ab 5 Jahre
-  ca. 6,00 x 5,20 m
-  ca. 3,08 x 1,80 m
-  ca. 3,80 m
-  ca. 2,30 m

-  ca. 3,80 x 4,10 x 1,00 m
-  ca. 100 kg
-  keine
-  1 St. 1,00 x 1,00 x 0,60 m  
4 St. 0,40 x 0,40 x 0,40 m

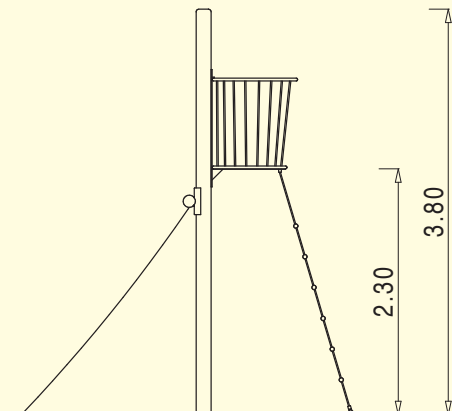
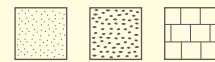

ohne Maßstab

\*02 Stahl verzinkt