



Hangel- und Balancierseil E-082

Art.-Nr.: 05.00.051.02



Sprossenwand mit 2er-Reck E-041

Art.-Nr.: 05.70.330.11



Balancierleiter E-118

Art.-Nr.: 05.60.330.11

Hangel- und Balancierseil E-082





Art.-Nr.: 05.00.051.02

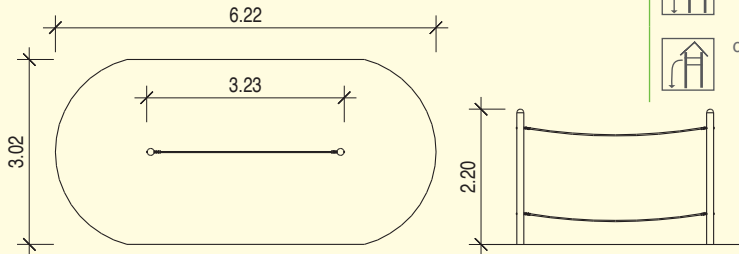



Material:

- Standpfosten aus verzinktem Stahlrohr, \varnothing 114 mm, wahlweise pulverbeschichtet
- Balancier- und Halteseil aus Polyamidstahltau, \varnothing 2 cm, 4-farbig



ohne Maßstab

-  ab 4 Jahre
-  ca. 6,22 x 3,02 m
-  ca. 3,23 x 0,114 m
-  ca. 2,20 m
-  ca. 0,30 m

-  ca. 3,00 x 0,20 m
-  ca. 60 kg
-  keine
-  2 St. 1,00 x 1,00 x 0,50 m

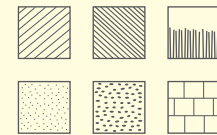

Sprossenwand mit 2er-Reck E-041





Art.-Nr.: 05.70.330.11

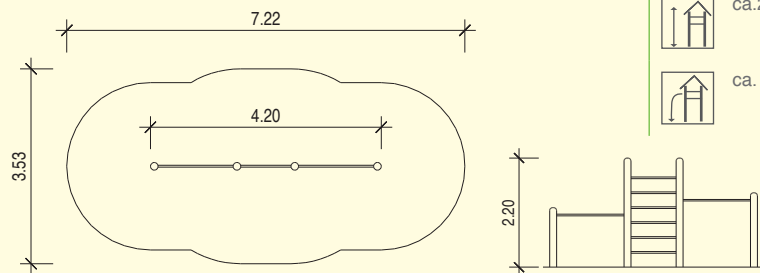



Material:

- Standpfosten aus Rundhölzern, \varnothing 14 cm / Rundrohr, \varnothing 114 mm Stahl verzinkt, wahlweise pulverbeschichtet
- Reckstangen aus V2A-Edelstahl
- Sprossen der Sprossenwand aus V2A-Edelstahl



ohne Maßstab

-  ab 3 Jahre
-  ca. 7,22 x 3,53 m
-  ca. 4,20 x 0,14 mm
-  ca. 2,20 m
-  ca. 1,85 m

-  ca. 3,00 x 1,20 x 0,14 m
-  ca. 105 kg
-  4 St. 11.00.005.62
-  4 St. 0,50 x 0,50 x 0,40 m

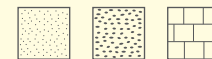

*11 Douglasie
*02 Stahl verzinkt

Balancierleiter E-118





Art.-Nr.: 05.60.330.11

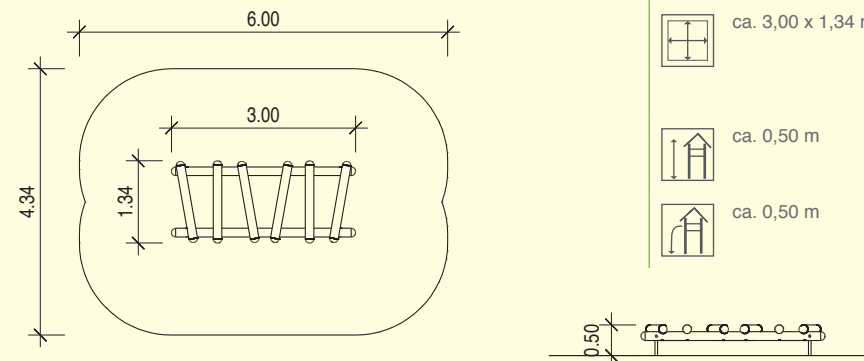



Material:

- Holme und Sprossen aus Rundholz \varnothing 14 cm
- Standpfosten aus Edelstahlrohr \varnothing 42,4 mm



ohne Maßstab

-  ab 3 Jahre
-  ca. 6,00 x 4,34 m
-  ca. 3,00 x 1,34 m
-  ca. 0,50 m
-  ca. 0,50 m

-  ca. 1,34 x 3,00 x 0,28 m
-  ca. 100 kg
-  inklusive
-  4 St. 0,50 x 0,50 x 0,40 m